

# Low profile lift tables for evenly distributed loads

## Model A8C-A8U-A8E

Low profile lift tables - not requiring a floor pit for even more flexibility

**GREEN LINE**

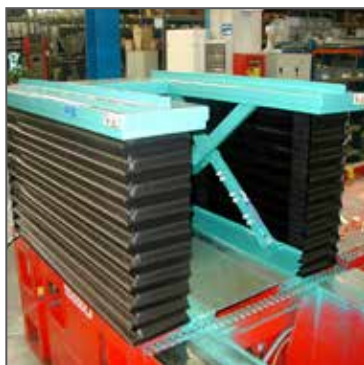

**BOLZONI** 

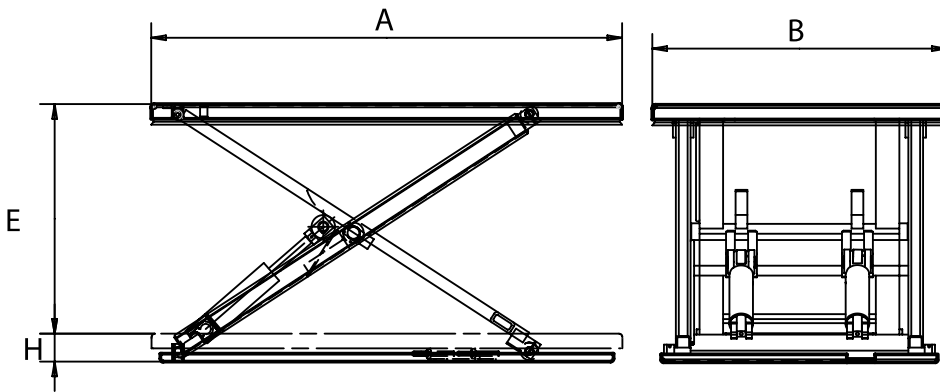

**Range:** 500 Kg - 2000 Kg

- Aluminium safety bar stops the descent of the platform in case of contact with obstructions.
- Single acting hydraulic cylinders equipped with hose safety valve, check valve and drainage.
- Low voltage "Hold-to-run" type control box fitted on remote power pack for easy operation.
- Mechanical stop screwed for safe servicing and maintenance operations.
- Removable lifting eye(s) to make easier handling and installation.
- Compliance with the Machinery Directive 2006/42CE and Safety Requirements for lift tables EN1570-1.

Low profile lift tables, due to their low closed height, do not require a floor pit, offering flexibility of location and keeping installation costs to a minimum.

Three versions are available:

**C** = closed top platform (access ramp is available on request)

**U** = U-shaped platform, particularly useful when loading a pallet safely onto the table using a hand pallet truck or pedestrian truck without the need for an access ramp.

**E** = E-shaped platform, offering superior pallet support, over the conventional "U-shape" platform.

Model	Capacity	Stroke	Platform	Collapsed Height	Motor	Cylinder
	kg	E mm	A x B mm	H mm	Kw	n. diam.
<b>Type A8.C closed top platform for evenly distributed loads</b>						
A8 05 C010	500	780	1400 x 800	82	0,75	1 60
A8 05 C020	500	780	1400 x 1000	82	0,75	1 60
A8 05 C030	500	780	1600 x 800	82	0,75	1 60
A8 05 C040	500	780	1600 x 1000	82	0,75	1 60
A8 10 C010	1000	780	1400 x 800	82	0,75	2 60
A8 10 C020	1000	780	1400 x 1000	82	0,75	2 60
A8 10 C030	1000	780	1600 x 800	82	0,75	2 60
A8 10 C040	1000	780	1600 x 1000	82	0,75	2 60
A8 15 C010	1500	750	1550 x 800	92	1,10	2 70
A8 15 C020	1500	750	1550 x 1000	92	1,10	2 70
A8 15 C030	1500	750	1700 x 800	92	1,10	2 70
A8 15 C040	1500	750	1700 x 1000	92	1,10	2 70
A8 20 C010	2000	750	1600 x 1000	95	1,10	2 70
A8 20 C020	2000	750	1600 x 1200	95	1,10	2 70
<b>Type A8.U – U shaped top platform for evenly distributed load</b>						
A8.10.U010	1000	780	1420 x 1140	80	0,75	2 60
A8.10.U110	1000	780	1420 x 1140	80	0,75	2 60
A8.10.U120	1000	780	1420 x 1290	80	0,75	2 60
A8.15.U010	1500	750	1550 x 1160	92	1,10	2 70
<b>Type – E shaped top platform for evenly distributed load</b>						
A8.10.E010	1000	780	1420 x 1140	80	0,75	2 60
A8.10.E110	1000	780	1420 x 1140	80	0,75	2 60
A8.10.E120	1000	780	1420 x 1290	80	0,75	2 60
A8.15.E010	1500	750	1550 x 1160	92	1,10	2 70

#### Additional dimensions for E-shaped and U-shaped top platforms

	C	D	F	G	H	I	L
A8.10.U-E010/110	277,5	585	370	1.050	217,5	150	600
A8.10.U-E120	277,5	735	370	1.050	292,5	150	600
A8.15.U-E010	287,5	585	425	1.125	217,5	150	600

#### CUSTOMIZED SOLUTIONS

Accessories available to provide customized solutions.

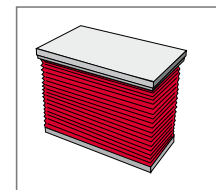

PVC bellow

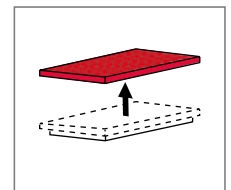

Safety treadplate platform surface

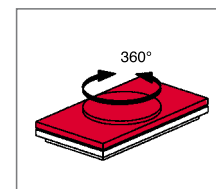

Manual circular turntable

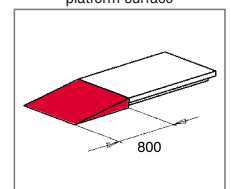

Connecting ramp

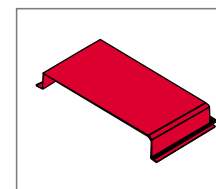

Mobility kit without the load



Mobility kit without the load

Bolzoni promotes environmental sustainable research and innovation.

For a lower impact on the environment, Bolzoni lift tables are available with biodegradable hydraulic oil on request, and are all provided with high-efficiency electric motors IE3. Lift tables are painted with water based nontoxic solvent free paint.

Bolzoni SpA lift tables facility is certified with the Environment Certificate ISO 14001:2015, since 2006..

BOLZONI S.p.A.

VIA I MAGGIO,103 - CASONI DI PODENZANO -  
29027 PIACENZA (ITALIA)

Tel. +39 0523 55 55 11 - Fax +39 0523 52 40 87

[www.bolzonigroup.com](http://www.bolzonigroup.com) - [sales@bolzonigroup.com](mailto:sales@bolzonigroup.com)