

Tandem scissor lift tables for evenly distributed loads

Model 5E

Handling extra long and heavy loads



BOLZONI 

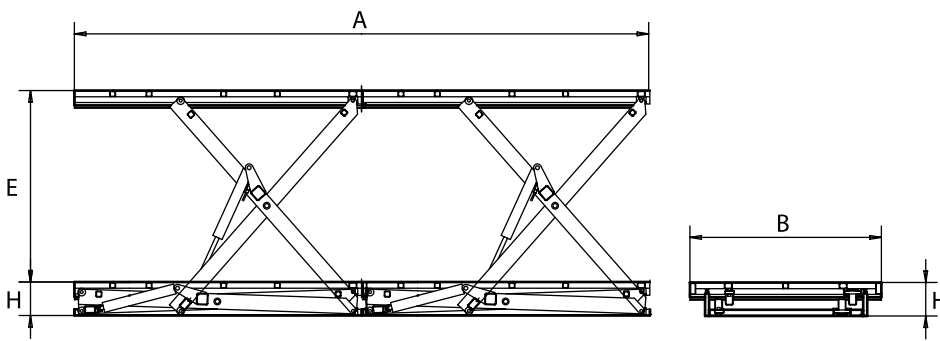

Range: 750 Kg - 3000 Kg

- Top platform smooth surface.
- Aluminium safety bar stops the descent of the platform in case of contact with obstructions
- Single acting hydraulic cylinders equipped with hose safety valve, check valve and drainage.
- Low voltage "Hold-to-run" type control box
- Mechanical locks for safe servicing and maintenance operations
- Removable lifting eye(s) to make easier handling and installation
- Synchronism connecting bars ensure an even increased safety and stability
- Compliance with the Machinery Directive 2006/42/CE and Safety Requirements for lift tables EN1570-1.

**Designed to handle extra long and heavy loads whilst keeping the closed dimension to a minimum.
For 5A lift tables range (for partially concentrated loads), special sizes and higher capacities consult Bolzoni.**

Model	Capacity	Stroke	Platform	Collapsed Height	Motor	Cylinder
	kg	E mm	A x B mm	H mm	Kw	n. diam.
A5 05 E910	750	800	2700 x 800	200	0,75	2 60
A5 05 E920	750	800	2700 x 1000	200	0,75	2 60
A5 05 E930	750	1000	3200 x 800	220	0,75	2 60
A5 05 E940	750	1000	3200 x 1000	220	0,75	2 60
A5 05 E950	750	1200	4000 x 800	240	0,75	2 60
A5 05 E960	750	1200	4000 x 1000	240	0,75	2 60
A5 10 E910	1500	800	2700 x 800	200	1,10	4 60
A5 10 E920	1500	800	2700 x 1000	200	1,10	4 60
A5 10 E930	1500	1000	3200 x 800	220	1,10	4 60
A5 10 E940	1500	1000	3200 x 1000	220	1,10	4 60
A5 10 E950	1500	1200	4000 x 800	240	1,10	4 60
A5 10 E960	1500	1200	4000 x 1000	240	1,10	4 60
A5 20 E910	3000	950	3200 x 800	260	1,50	2 110
A5 20 E920	3000	950	3200 x 1000	260	1,50	2 110
A5 20 E930	3000	1200	3800 x 800	270	1,50	2 110
A5 20 E940	3000	1200	3800 x 1000	270	1,50	2 110

CUSTOMIZED SOLUTIONS

Thanks to our experience and a wide range of accessories available, we are able to provide customized solutions to improve productivity, efficiency and safety to suit all specific requirements.

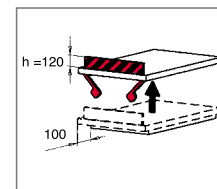

Roll-off stop

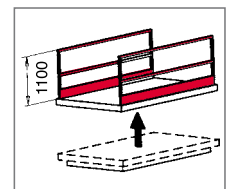

Safety handrails

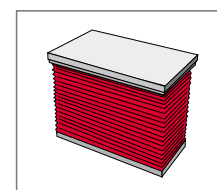

PVC bellow

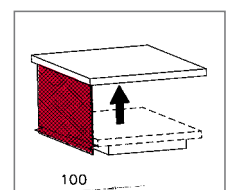

Mesh curtain

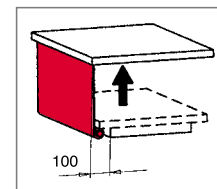

PVC rolling curtain

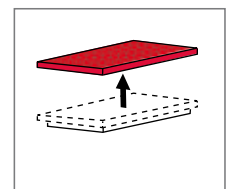

Safety treadplate platform surface

Bolzoni promotes environmental sustainable research and innovation.

For a lower impact on the environment, Bolzoni lift tables are available with biodegradable hydraulic oil on request, and are all provided with high-efficiency electric motors IE3. Lift tables are painted with water based nontoxic solvent free paint.

Bolzoni SpA lift tables facility is certified with the Environment Certificate ISO 14001:2015, since 2006.

BOLZONI S.p.A.

VIA I MAGGIO,103 - CASONI DI PODENZANO -
29027 PIACENZA (ITALIA)

Tel. +39 0523 55 55 11 - Fax +39 0523 52 40 87

www.bolzonigroup.com - sales@bolzonigroup.com

BOLZONI